

## MODEL LD - LARGE DC VOLT/CURRENT/PROCESS DISPLAY



- 2.25" & 4" HIGH RED LED DIGITS
- PROGRAMMABLE SCALING AND DECIMAL POINTS
- PROGRAMMABLE USER INPUT
- DUAL 5 AMP FORM C RELAY
- ALUMINUM NEMA 4X/IP65 CASE CONSTRUCTION
- RS232/RS485 SERIAL COMMUNICATIONS
- UNIVERSALLY POWERED

### GENERAL DESCRIPTION

The Large Display is a versatile display available as a DC volt, current, or process meter with scaling, serial communications and dual relay outputs. The 5 digit displays are available in either 2.25" or 4" high red LED digits with adjustable display intensities. The 2.25" high models are readable up to 130 feet. The 4" high models are readable up to 180 feet. Both versions are constructed of a NEMA 4X/IP65 enclosure in light weight aluminum.

All models also come with dual Form C relay outputs and RS232 / RS485 serial communications.

### SAFETY SUMMARY

All safety regulations, local codes and instructions that appear in this and corresponding literature, or on equipment, must be observed to ensure personal safety and to prevent damage to either the instrument or equipment connected to it. If equipment is used in a manner not specified by the manufacturer, the protection provided by the equipment may be impaired.

**CAUTION: Risk of Danger.**  
Read complete instructions prior to installation and operation of the unit.

**CAUTION: Risk of electric shock.**

The protective conductor terminal is bonded to conductive parts of the equipment for safety purposes and must be connected to an external protective earthing system.

### ORDERING INFORMATION

MODEL NO.	DESCRIPTION	PART NUMBER
LD2A	2.25" High 5 Digit Red LED Volt/Current Meter w/ Relay Output and RS232/RS485 Serial Comms	LD2A05P0
LD4A	4" High 5 Digit Red LED Volt/Current Meter w/ Relay Output and RS232/RS485 Serial Comms	LD4A05P0
LD Plug	Cord Grip Plug for LD models *	LDPLUG00

\* Required to maintain Type 4X/IP65 specification, if end plate cord grip does not have cable installed.

### DIMENSIONS In inches (mm)

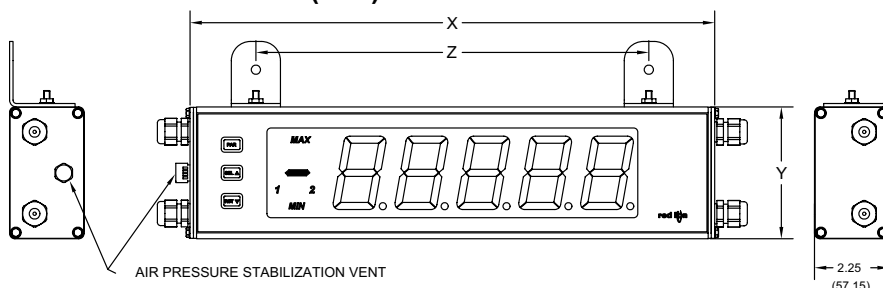

PART NUMBER	X (Length)	Y (Height)	Z (Center)
LD2A05P0	16 (406.4)	4 (101.6)	12 (304.3)
LD4A05P0	26 (660.4)	7.875 (200)	22 (558.8)

### SPECIFICATIONS

- DISPLAY:** 5 digit, 2.25" (57 mm) or 4" (101 mm) intensity adjustable Red LED (-99999 to 99999)
- POWER REQUIREMENTS:**  
 AC POWER: 50 to 250 VAC 50/60 Hz, 26 VA  
 DC POWER: 21.6 to 250 VDC, 11 W  
 DC Out: +24 VDC @ 100 mA if input voltage is greater than 50 VAC/VDC  
 +24 VDC @ 50 mA if input voltage is less than 50 VDC  
 Isolation: 3000 Vrms for 1 min. to all inputs and outputs
- INPUT RANGES:** Jumper Selectable  
**D.C. Voltages:** 200 mV, 2 V, 20 V, 200 V, 10 V

INPUT RANGE	ACCURACY @ 23 °C LESS THAN 85% RH	INPUT IMPEDANCE	MAX INPUT SIGNAL	RESOLUTION	TEMP. COEFFICIENT
200 mV	0.1% of span	1.033 MΩ	75 VDC	10 μV	70 ppm /°C
2 V	0.1% of span	1.033 MΩ	75 VDC	0.1 mV	70 ppm /°C
10 V	0.1% of span	1.033 MΩ	250 VDC	1 mV	70 ppm /°C
20 V	0.1% of span	1.033 MΩ	250 VDC	1 mV	70 ppm /°C
200 V	0.1% of span	1.033 MΩ	250 VDC	10 mV	70 ppm /°C

**D.C. Currents:** 200 μA, 2 mA, 20 mA, 200 mA

INPUT RANGE	ACCURACY @ 23 °C LESS THAN 85% RH	INPUT IMPEDANCE	MAX INPUT SIGNAL	RESOLUTION	TEMP. COEFFICIENT
200 μA	0.1% of span	1.111 KΩ	15 mA	10 nA	70 ppm /°C
2 mA	0.1% of span	111 Ω	50 mA	0.1 μA	70 ppm /°C
20 mA	0.1% of span	11 Ω	150 mA	1 μA	70 ppm /°C
200 mA	0.1% of span	1 Ω	500 mA	10 μA	70 ppm /°C

**D.C. Process:** 4 to 20 mA, 1 to 5 VDC, 0/1 to 10 VDC

INPUT RANGE	SELECT RANGE
4 - 20 mA	Use the 20 mA range
1 - 5 VDC	Use the 10V range
1 - 10 VDC	Use the 10V range

### 4. OVERRANGE/UNDERRANGE INDICATION:

**Input Overrange Indication:** "0000"

**Input Underrange Indication:** "0000"

**Display Overrange/Underrange Indication:** "....."/"-----"

5. **A/D CONVERTER:** 16 bit resolution  
**A/D Conversion Rate:** 6 readings/sec.
6. **DISPLAY RESPONSE TIME:** 500 msec min.
7. **USER INPUT:**  
 Software selectable pull-up (8.6 K $\Omega$ ) or pull-down resistor (3.9 K $\Omega$ ) that determines active high or active low input logic.  
 Trigger levels:  $V_{IL}$  = 1.0 V max;  $V_{IH}$  = 2.4 V min;  $V_{MAX}$  = 28 VDC  
 Response Time: 5 msec typ.; 50 msec debounce (activation and release)
8. **COMMUNICATIONS:**  
**Type:** RS485 or RS232  
**Isolation To Sensor & User Input Commons:** 500 Vrms for 1 min.  
 Working Voltage: 50 V. Not Isolated from all other commons.  
**Data:** 7/8 bits  
**Parity:** no, odd or even  
**Baud Rate:** 300 to 38.4 K  
**Bus Address:** Selectable 0 to 99, Max. 32 meters per line (RS485)
9. **MEMORY:** Nonvolatile E<sup>2</sup>PROM retains all programming parameters and max/min values when power is removed.
10. **OUTPUT:**  
**Type:** Single FORM-C relay  
**Isolation To Sensor & User Input Commons:** 1500 Vrms for 1 min.  
 Working Voltage: 150 Vrms  
**Contact Rating:** 5 amps @ 120/240 VAC or 28 VDC (resistive load), 1/8 H.P. @ 120 VAC (inductive load)  
**Life Expectancy:** 100,000 minimum operations  
**Response Time:**  
 Turn On Time: 4 msec max.  
 Turn Off Time: 4 msec max.
11. **ENVIRONMENTAL CONDITIONS:**  
 Operating temperature: 0 to 65 °C  
 Storage temperature: -40 to 70 °C  
 Operating and storage humidity: 0 to 85% max. RH (non-condensing)  
 Vibration to IEC 68-2-6: Operational 5 to 150 Hz, 2 g (1 g relay).  
 Shock to IEC 68-2-27: Operational 30 g (10 g relay).  
 Altitude: Up to 2,000 meters

12. **CONNECTIONS:** Internal removable terminal blocks  
 Wire Strip Length: 0.4" (10 mm)  
 Wire Gauge: 24-12 AWG (0.51-2.05 mm) copper wire, 90 °C rated insulation only  
 Torque: 5.3 inch-lbs (0.6 N-m) max.  
 Cable Diameter: Outside diameter must be 0.181" (4.6 mm) to 0.312" (7.9 mm) to maintain Type 4X rating of cord grips.
13. **CONSTRUCTION:** Aluminum enclosure, and steel side panels with textured black polyurethane paint for scratch and corrosion resistance protection. Meets Type 4X/IP65 specifications. Installation Category II, Pollution Degree 2.
11. **CERTIFICATIONS AND COMPLIANCES:**  
**CE Approved**  
 EN 61326-1 Immunity to Industrial Locations  
 Emission CISPR 11 Class B  
 Safety requirements for electrical equipment for measurement, control, and laboratory use:  
 EN 61010-1: General Requirements  
 EN 61010-2-030: Particular Requirements for Testing and Measuring Circuits  
 RoHS Compliant  
 UL Listed: File #E137808  
 Type 4X Indoor/Outdoor Enclosure rating  
 IP65 Enclosure rating
15. **WEIGHT:**  
 LD2A05XX - 4.5 lbs (2.04 kg)  
 LD4A05XX - 10.5 lbs (4.76 kg)

# 1.0 INSTALLING THE METER

## INSTALLATION

The meter meets NEMA 4X/IP65 requirements when properly installed.

## INSTALLATION ENVIRONMENT

The unit should be installed in a location that does not exceed the operating temperature. Placing the unit near devices that generate excessive heat should be avoided. The unit should only be cleaned with a soft cloth and neutral soap product. Do NOT use solvents.

Continuous exposure to direct sunlight may accelerate the aging process of the front overlay. Do not use tools of any kind (screwdrivers, pens, pencils, etc.) to operate the keypad of the unit.

## MOUNTING INSTRUCTIONS

This display is designed to be wall mounted or suspended from a ceiling truss or other suitable structure capable of supporting the LDA. Caution should be exercised when hanging the display to provide for the safety of personnel. If hanging the LDA, run the suspension cables (or chains) through the mounting bracket holes. For wall mounting use #10-32 size bolts.

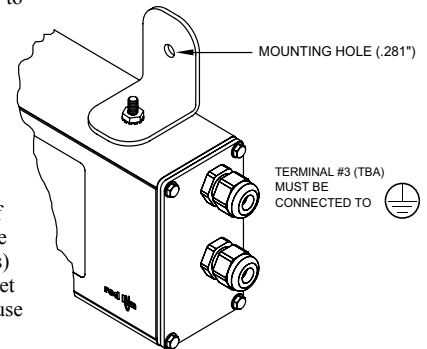

# 2.0 SETTING THE JUMPERS

## INPUT RANGE JUMPER

This jumper is used to select the proper input range. The input range selected in programming must match the jumper setting. Select a range that is high enough to accommodate the maximum signal input to avoid overloads. To access the jumper, remove the side cover of the meter.



**Warning:** Exposed line voltage exists on the circuit boards. Remove all power to the meter and load circuits before accessing inside of the meter.

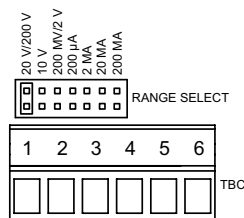

# 3.0 WIRING THE METER

## EMC INSTALLATION GUIDELINES

Although Red Lion Controls Products are designed with a high degree of immunity to Electromagnetic Interference (EMI), proper installation and wiring methods must be followed to ensure compatibility in each application. The type of the electrical noise, source or coupling method into a unit may be different for various installations. Cable length, routing, and shield termination are very important and can mean the difference between a successful or troublesome installation. Listed are some EMI guidelines for a successful installation in an industrial environment.

1. A unit should be mounted in a metal enclosure, which is properly connected to protective earth.
2. Use shielded cables for all Signal and Control inputs. The shield connection should be made as short as possible. The connection point for the shield depends somewhat upon the application. Listed below are the recommended methods of connecting the shield, in order of their effectiveness.
  - a. Connect the shield to earth ground (protective earth) at one end where the unit is mounted.
  - b. Connect the shield to earth ground at both ends of the cable, usually when the noise source frequency is over 1 MHz.
3. Never run Signal or Control cables in the same conduit or raceway with AC power lines, conductors, feeding motors, solenoids, SCR controls, and heaters, etc. The cables should be run through metal conduit that is properly grounded. This is especially useful in applications where cable runs are long and portable two-way radios are used in close proximity or if the installation is near a commercial radio transmitter. Also, Signal or Control cables within an enclosure should be routed as far away as possible from contactors, control relays, transformers, and other noisy components.
4. Long cable runs are more susceptible to EMI pickup than short cable runs.
5. In extremely high EMI environments, the use of external EMI suppression devices such as Ferrite Suppression Cores for signal and control cables is effective. The following EMI suppression devices (or equivalent) are recommended:

Fair-Rite part number 0443167251 (RLC part number FCOR0000)

Line Filters for input power cables:

Schaffner # FN2010-1/07 (Red Lion Controls # LFIL0000)

6. To protect relay contacts that control inductive loads and to minimize radiated and conducted noise (EMI), some type of contact protection network is normally installed across the load, the contacts or both. The most effective location is across the load.
  - a. Using a snubber, which is a resistor-capacitor (RC) network or metal oxide varistor (MOV) across an AC inductive load is very effective at reducing EMI and increasing relay contact life.
  - b. If a DC inductive load (such as a DC relay coil) is controlled by a transistor switch, care must be taken not to exceed the breakdown voltage of the transistor when the load is switched. One of the most effective ways is to place a diode across the inductive load. Most RLC products with solid state outputs have internal zener diode protection. However external diode protection at the load is always a good design practice to limit EMI. Although the use of a snubber or varistor could be used.

RLC part numbers: Snubber: SNUB0000

Varistor: ILS11500 or ILS23000

7. Care should be taken when connecting input and output devices to the instrument. When a separate input and output common is provided, they should not be mixed. Therefore a sensor common should NOT be connected to an output common. This would cause EMI on the sensitive input common, which could affect the instrument's operation.

Visit RLC's web site at <http://www.redlion.net/emi> for more information on EMI guidelines, Safety and CE issues as they relate to Red Lion Controls products.

## WIRING OVERVIEW

Electrical connections are made via pluggable terminal blocks located inside the meter. All conductors should conform to the meter's voltage and current ratings. All cabling should conform to appropriate standards of good installation, local codes and regulations. It is recommended that the power supplied to the meter (DC or AC) be protected by a fuse or circuit breaker. When wiring the meter, compare the numbers on the label on the back of the meter case against those shown in wiring drawings for proper wire position. Strip the wire, leaving approximately 0.4" (10 mm) bare lead exposed (stranded wires should be tinned

with solder.) Insert the lead under the correct screw clamp terminal and tighten until the wire is secure. (Pull wire to verify tightness.) Each terminal can accept up to one #14 AWG (2.55 mm) wire, two #18 AWG (1.02 mm), or four #20 AWG (0.61 mm). Use copper conductors only, with insulation rated at 90°C.

## WIRING CONNECTIONS

Internal removable terminal blocks are used for power and signal wiring. Access to terminal blocks is through conduit fittings. Remove end plates with ¼" nut driver. For LD4 versions, all wiring is on right side of unit. For LD2 versions, power and relay wiring is on the right side and the input, serial, DC out and user input is on the left side.

Feed the wire stripped end of cable(s) through the cord grip(s). Un-plug the internal removable terminal blocks and wire appropriately.

Plug in the terminal blocks, connect the drain wire from shielded cable(s) to the screw on the side plate for proper grounding, and slide the end plate(s) into place and tighten to case. Hand tighten all cap screws and then tighten the cap screws at the opposite corner diagonally.

**Important:** To maintain the Type 4X/IP65 specification, the cord grip must be tightened around a cable with an outside diameter of 0.181" (4.6 mm) to 0.312" (7.9 mm). If the cord grip is unused, remove it and replace with the LD cord grip plug (part # LDPLUG00). The LDPLUG00 must be ordered separately.

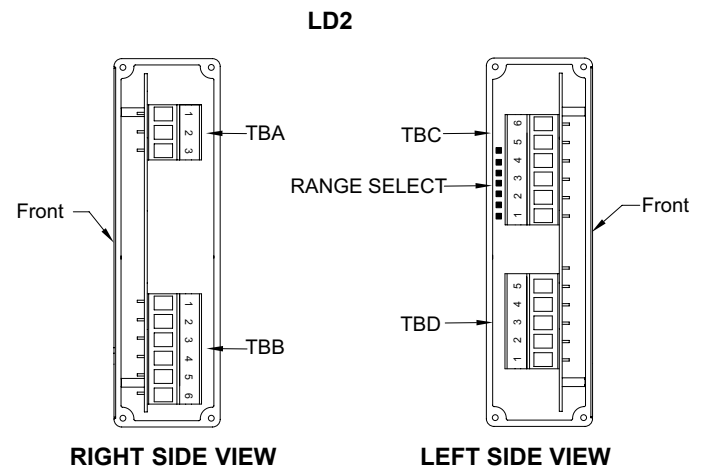
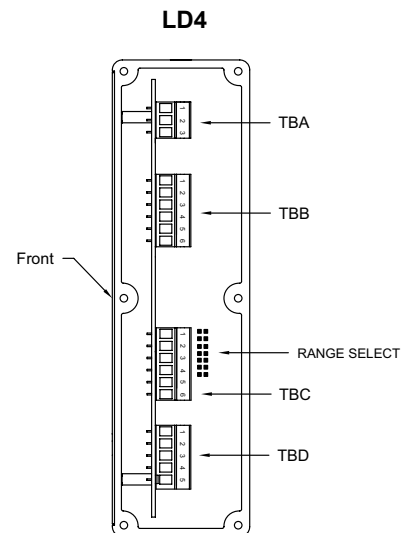

RIGHT SIDE VIEW

LEFT SIDE VIEW

### 3.1 POWER WIRING

The power wiring is made via the 3 position terminal block (TBA) located inside the unit (right side). The DC out power is located: LD2 - left side, LD4 - right side

#### Power

- Terminal 1: VAC/DC +
- Terminal 2: VAC/DC -
- Terminal 3: Protective Conductor Terminal

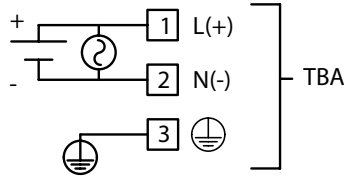

#### DC Out Power

- Terminal 4: + 24 VDC OUT
- Terminal 6: User Common

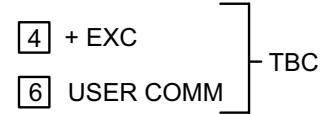

### 3.2 INPUT WIRING

Before connecting signal wires, the Input Range Jumper should be verified for proper position.

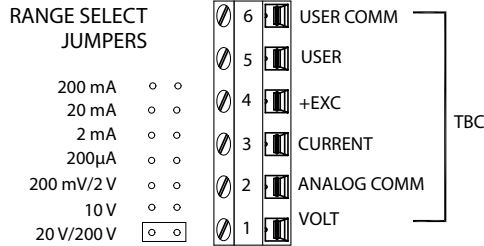

**CAUTION:** Analog common is NOT isolated from user input common. In order to preserve the safety of the meter application, the DC common must be suitably isolated from hazardous live earth referenced voltage; or input common must be at protective earth ground potential. If not, hazardous voltage may be present at the User Input and Input Common terminals. Appropriate considerations must then be given to the potential of the input common with respect to earth ground. Always connect the analog signal common to terminal 2.

### INPUT SIGNAL WIRING

#### Voltage Signal (self powered)

- Terminal 1: +VDC
- Terminal 2: -VDC

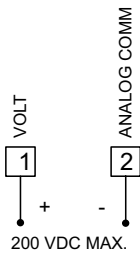

#### Current Signal (self powered)

- Terminal 3: +ADC
- Terminal 2: -ADC

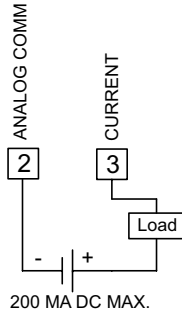

#### Current Signal (2 wire requiring excitation)

- Terminal 4: +EXC
- Terminal 3: +ADC

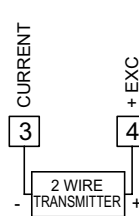

#### Current Signal (3 wire requiring excitation)

- Terminal 3: +ADC (signal)
- Terminal 2: -ADC (common)
- Terminal 4: +EXC

#### Voltage Signal (3 wire requiring excitation)

- Terminal 1: +VDC (signal)
- Terminal 2: -VDC (common)
- Terminal 4: +EXC

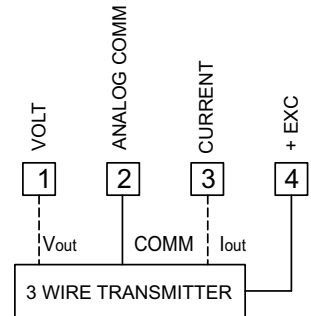

### USER INPUT WIRING

The User Input is located: LD2 - left side, LD4 - right side

- Terminal 5: User Input
- Terminal 6: User Comm

#### Sinking Logic

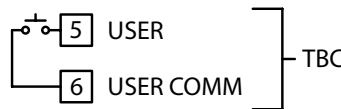

#### Sourcing Logic

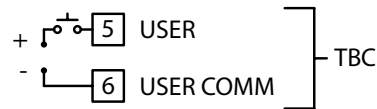

### 3.3 SETPOINT (OUTPUT) WIRING

The setpoint relays use a six position terminal block (TBB) located inside the (right side).

- Terminal 1: NC 1
- Terminal 2: NO 2
- Terminal 3: Relay 1 Common
- Terminal 4: NC 1
- Terminal 5: NO 2
- Terminal 6: Relay 2 Common

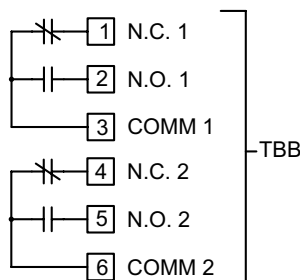

### 3.4 SERIAL WIRING

The serial connections are made via terminal block TBD located inside the unit on the left side for the LD2 and on the right side for the LD4.

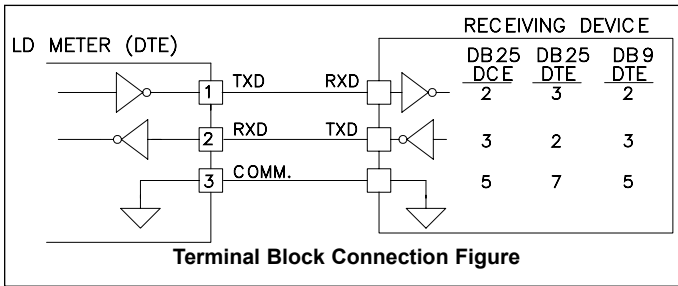
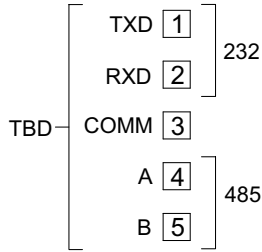

#### RS485 Communications

The RS485 communication standard allows the connection of up to 32 devices on a single pair of wires, distances up to 4,000 ft. and data rates as high as 10M baud (the LDA is limited to 38.4k baud). The same pair of wires is used to both transmit and receive data. RS485 is therefore always half-duplex, that is, data cannot be received and transmitted simultaneously.

#### RS232 Communications

RS232 is intended to allow two devices to communicate over distances up to 50 feet. Data Terminal Equipment (DTE) transmits data on the Transmitted Data (TXD) line and receives data on the Received Data (RXD) line. Data Computer Equipment (DCE) receives data on the TXD line and transmits data on the RXD line. The LD emulates a DTE. If the other device connected to the meter also emulates a DTE, the TXD and RXD lines must be interchanged for communications to take place. This is known as a null modem connection. Most printers emulate a DCE while most computers emulate a DTE device.

Some devices cannot accept more than two or three characters in succession without a pause in between. In these cases, the meter employs a busy function.

As the meter begins to transmit data, the RXD line (RS232) is monitored to determine if the receiving device is "busy". The receiving device asserts that it is busy by setting the RXD line to a space condition (logic 0). The meter then suspends transmission until the RXD line is released by the receiving device.

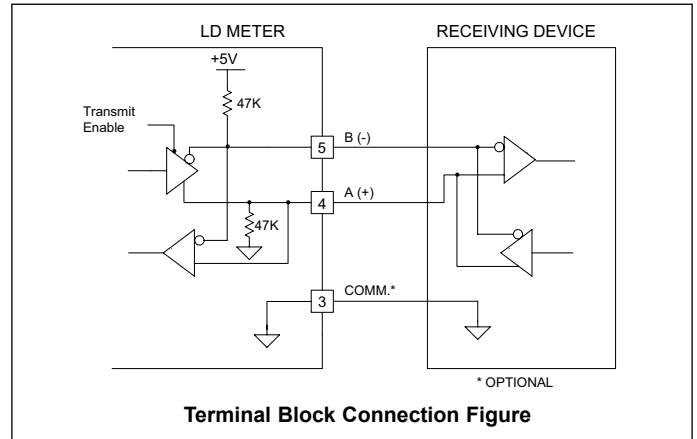

## 4.0 REVIEWING THE FRONT BUTTONS AND DISPLAY



#### BUTTON DISPLAY MODE OPERATION

- PAR** Access Programming Mode
- SEL▲** Index display through selected displays
- RST▼** Resets display

#### PROGRAMMING MODE OPERATION

- Store selected parameter and index to next parameter
- Advance through selection list/select digit position in parameter value
- Increment selected digit of parameter value

#### OPERATING MODE DISPLAY DESIGNATORS

- MAX - Maximum display capture value
- MIN - Minimum display capture value

- "1" - To the left of the display indicates setpoint 1 output activated.
- "2" - To the left of the display indicates setpoint 2 output activated.

Pressing the **SEL▲** button toggles the meter through the selected displays. If display scroll is enabled, the display will toggle automatically every four seconds between the enabled display values.

# 5.0 PROGRAMMING THE METER

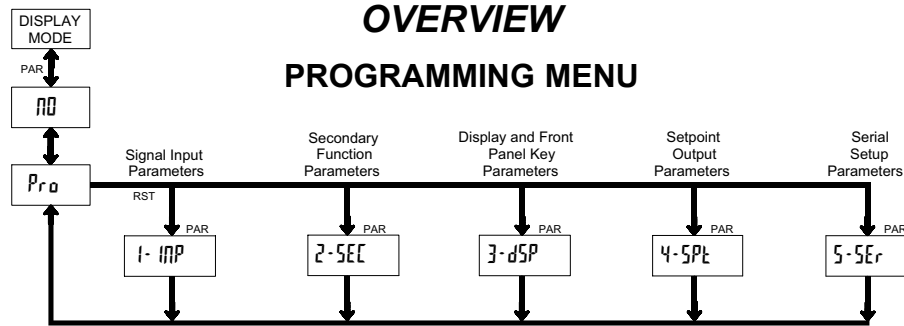

## PROGRAMMING MODE ENTRY (PAR BUTTON)

It is recommended all programming changes be made off line, or before installation. The meter normally operates in the Display Mode. No parameters can be programmed in this mode. The Programming Mode is entered by pressing the **PAR** button. If it is not accessible, then it is locked by either a security code or a hardware lock.

## MODULE ENTRY (SEL▲ & PAR BUTTONS)

The Programming Menu is organized into five modules. These modules group together parameters that are related in function. The display will alternate between **Pr0** and the present module. The **SEL▲** button is used to select the desired module. The displayed module is entered by pressing the **PAR** button.

## MODULE MENU (PAR BUTTON)

Each module has a separate module menu (which is shown at the start of each module discussion). The **PAR** button is pressed to advance to a particular parameter to be changed, without changing the programming of preceding parameters. After completing a module, the display will return to **Pr0**. Programming may continue by accessing additional modules.

## SELECTION / VALUE ENTRY

For each parameter, the display alternates between the present parameter and the selections/value for that parameter. The **SEL▲** and **RST▼** buttons are used to move through the selections/values for that parameter. Pressing the **PAR** button, stores and activates the displayed selection/value. This also advances the meter to the next parameter.

For numeric values, the value is displayed with one digit flashing (initially the right most digit). Pressing the **RST▼** button increments the digit by one or the user can hold the **RST▼** button and the digit will automatically scroll. The **SEL▲** button will select the next digit to the left. Pressing the **PAR** button will enter the value and move to the next parameter.

## PROGRAMMING MODE EXIT (PAR BUTTON)

The Programming Mode is exited by pressing the **PAR** button with **Pr0** displayed. This will commit any stored parameter changes to memory and return the meter to the Display Mode. (If power loss occurs before returning to the Display Mode, verify recent parameter changes.)

## PROGRAMMING TIPS

It is recommended to start with Module 1 and proceed through each module in sequence. When programming is complete, it is recommended to record the parameter programming and lock out parameter programming with the user input or programming security code.

## FACTORY SETTINGS

Factory Settings may be completely restored in Module 2. This is useful when encountering programming problems.

## ALTERNATING SELECTION DISPLAY

In the explanation of the modules, the following dual display with arrows will appear. This is used to illustrate the display alternating between the parameter on top and the parameter's Factory Setting on the bottom. In most cases, selections and values for the parameter will be listed on the right.

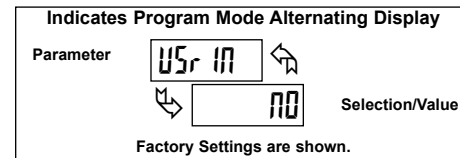

# 5.1 MODULE 1 - SIGNAL INPUT PARAMETERS (1-IMP)

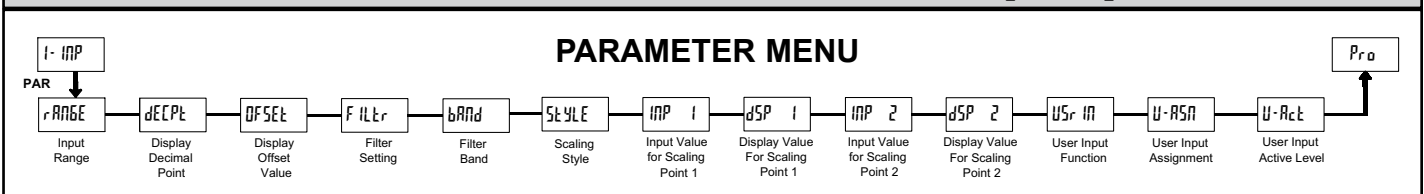

## INPUT RANGE

SELECTION	RANGE RESOLUTION	SELECTION	RANGE RESOLUTION
200uA	200.00 uA	002A	20.000 mA
0002A	2.0000 mA	0.2A	200.00 mA
0.2u	200.00 mV	20u	20.000 V
2u	2.0000 V	200u	200.00 V
10u	10.000 V		

Select the input range that corresponds to the external signal. This selection should be high enough to avoid input signal overload but low enough for the desired input resolution. This selection and the position of the Input Range Jumper must match.

## DISPLAY DECIMAL POINT



Select the decimal point location for the Input, MIN and MAX displays. This selection also affects the **dSP 1** and **dSP 2** parameters and setpoint values and offset value.

## DISPLAY OFFSET VALUE



The display can be corrected with an offset value. This can be used to compensate for signal variations or sensor errors. This value is automatically

updated after a Zero Display to show how far the display is offset. A value of zero removes the effects of offset. The decimal point follows the **dECPt** selection.

### FILTER SETTING



If the displayed value is difficult to read due to small process variations or noise, increased levels of filtering will help to stabilize the display. Software filtering effectively combines a fraction of the current input reading with a fraction of the previous displayed reading to generate the new display.

Filter values represent no filtering (0), up to heavy filtering (3). A value of 1 for the filter uses 1/4 of the new input and 3/4 of the previous display to generate the new display. A filter value of 2 uses 1/8 new and 7/8 previous. A filter value of 3 uses 1/16 new and 15/16 previous.

### FILTER BAND



The filter will adapt to variations in the input signal. When the variation exceeds the input filter band value, the filter disengages. When the variation becomes less than the band value, the filter engages again. This allows for a stable readout, but permits the display to settle rapidly after a large process change. The value of the band is in display units, independent of the Display Decimal Point position. A band setting of '0' keeps the filter permanently engaged at the filter level selected above.

### SCALING STYLE

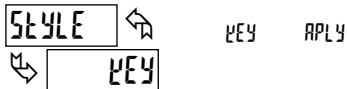

If Input Values and corresponding Display Values are known, the Key-in (**KEY**) scaling style can be used. This allows scaling without the presence or changing of the input signal. If Input Values have to be derived from the actual input signal source or simulator, the Apply (**APLY**) scaling style must be used.

### INPUT VALUE FOR SCALING POINT 1



For Key-in (**KEY**) style, enter the first Input Value using the front panel buttons. (The Input Range selection sets the decimal location for the Input Value).

For Apply (**APLY**) style, the meter shows the previously stored Input Value. To retain this value, press the **SEL▲** button to advance to the next parameter. To change the Input Value, press the **RST▼** button and apply the input signal to the meter. Adjust the signal source externally until the desired Input Value appears. Press the **SEL▲** button to enter the value being displayed.

### DISPLAY VALUE FOR SCALING POINT 1



Enter the first Display Value by using the front panel buttons. This is the same for **KEY** and **APLY** scaling styles. The decimal point follows the **dECPt** selection.

### INPUT VALUE FOR SCALING POINT 2



For Key-in (**KEY**) style, enter the known second Input Value using the front panel buttons.

For Apply (**APLY**) style, the meter shows the previously stored Input Value for Scaling Point 2. To retain this value, press the **SEL▲** button to advance to the next parameter. To change the Input Value, press the **RST▼** button and apply the input signal to the meter. Adjust the signal source externally until the desired Input Value appears. Press the **SEL▲** button to enter the value being displayed.

### DISPLAY VALUE FOR SCALING POINT 2



Enter the second Display Value by using the front panel buttons. This is the same for **KEY** and **APLY** scaling styles. The decimal point follows the **dECPt** selection.

### General Notes on Scaling

1. When using the Apply (**APLY**) scaling style, input values for scaling points must be confined to the range limits shown.
2. The same Input Value should not correspond to more than one Display Value. (Example: 20 mA can not equal 0 and 20.)
3. For input levels beyond the programmed Input Values, the meter extends the Display Value by calculating the slope from the two coordinate pairs (**INP 1** / **dSP 1** & **INP 2** / **dSP 2**).

### USER INPUT FUNCTION

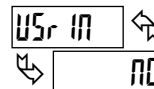

DISPLAY MODE	DESCRIPTION
<b>NO</b> No Function	User Input disabled.
<b>P-Loc</b> Program Mode Lock-out	See Programming Mode Access chart (Module 3).
<b>ZErO</b> Zero Input (Edge triggered)	Zero the Input Display value causing Display Reading to be Offset.
<b>rESEt</b> Reset (Edge triggered)	Resets the assigned value(s) to the current input value.
<b>d-Hld</b> Display Hold	Holds the assigned display, but all other meter functions continue as long as activated (maintained action).
<b>d-SEL</b> Display Select (Edge Triggered)	Advance once for each activation.
<b>d-LEU</b> Display Intensity Level (Edge Triggered)	Increase intensity one level for each activation.
<b>Pr int</b> Print Request	Serial transmit of the active parameters selected in the Print Options menu (Module 5).
<b>P-rSt</b> Print and Reset	Same as Print Request followed by a momentary reset of the assigned value(s).
<b>rSt-1</b> Setpoint 1 Reset	Resets setpoint 1 output.
<b>rSt-2</b> Setpoint 2 Reset	Resets setpoint 2 output.
<b>rSt-12</b> Setpoint 1 and 2 Reset	Reset both setpoint 1 and 2 outputs.

### USER INPUT ASSIGNMENT



Select the value(s) to which the User Input Function is assigned. The User Input Assignment only applies if a selection of reset, display hold, or print and reset is selected in the User Input Function menu.

### USER INPUT ACTIVE LEVEL



Select whether the user input is configured as active low or active high.



# 5.2 MODULE 2 - SECONDARY FUNCTION PARAMETERS (2-5EE)

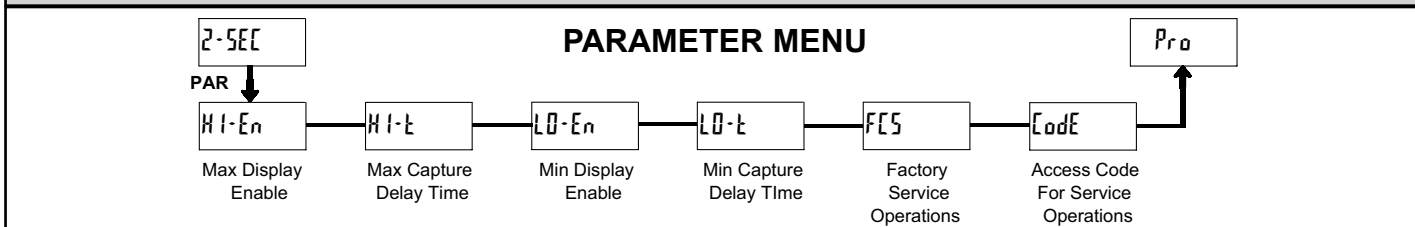

## MAX DISPLAY ENABLE

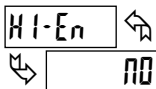

Enables the Maximum Display Capture capability.

## MAX CAPTURE DELAY TIME

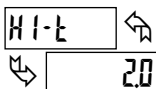

When the Input Display is above the present MAX value for the entered delay time, the meter will capture that display value as the new MAX reading. A delay time helps to avoid false captures of sudden short spikes.

## MIN DISPLAY ENABLE

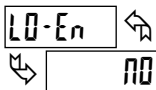

Enables the Minimum Display Capture capability.

## MIN CAPTURE DELAY TIME

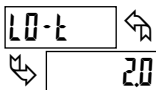

When the Input Display is below the present MIN value for the entered delay time, the meter will capture that display value as the new MIN reading. A delay time helps to avoid false captures of sudden short spikes.

## FACTORY SERVICE OPERATIONS

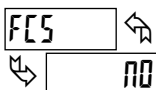

Select YES to perform either of the Factory Service Operations shown below.

## RESTORE FACTORY DEFAULT SETTINGS

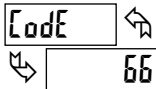

Entering Code 66 will overwrite all user settings with the factory settings. The meter will display rESEt and then return to Code 00. Press the PAR button to exit the module.

## VIEW MODEL AND VERSION DISPLAY

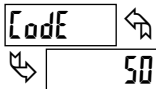

Entering Code 50 will display the model (LDA) and version (x.x) of the meter. The display then returns to Code 00. Press the PAR button to exit the module.

## CALIBRATION



The LD uses stored calibration values to provide accurate measurements. Over time, the electrical characteristics of the components inside the LD will slowly change with the result that the stored calibration values no longer accurately define the input circuit. For most applications, recalibration every 1 to 2 years should be sufficient.

Calibration of the LD involves a calibration which should only be performed by individuals experienced in calibrating electronic equipment. Allow 30 minute warm up before performing any calibration related procedure. The following procedures should be performed at an ambient temperature of 15 to 35 °C (59 to 95 °F).

*CAUTION: The accuracy of the calibration equipment will directly affect the accuracy of the LD.*

### Current Calibration

1. Connect the negative lead of a precision DC current source with an accuracy of 0.01% or better to the COMM terminal. Leave the positive lead of the DC current source unconnected.
2. With the display at Code 48, press the PAR button. Unit will display [RL 00]
3. Press the RST button to select the range to be calibrated.
4. Press the PAR button. Display reads 000
5. With the positive lead of the DC current source unconnected, press PAR. Display reads [RL] for about 8 seconds.
6. When the display reads the selected range, connect the positive lead of the DC current source to the current input and apply full-scale input signal for the range. (Note: For 200 mA range, apply 100 mA as indicated on the display.) Press PAR. Display reads [RL] for about 8 seconds.
7. Repeat steps 3 through 6 for each input range to be calibrated. When display reads [RL 00], press the PAR button to exit calibration.

### Voltage Calibration

1. Connect a precision DC voltage source with an accuracy of 0.01% or better to the volt input and COMM terminals of the LD. Set the output of the voltage source to zero.
2. With the display at Code 48, press the PAR button. Unit will display [RL 00].
3. Press the RST button to select the range to be calibrated.
4. Press the PAR button. Display reads 000.
5. With the voltage source set to zero (or a dead short applied to the input), press PAR. Display reads [RL] for about 8 seconds.
6. When the display reads the selected range, apply full-scale input signal for the range. (Note: For 200V range, apply 100V as indicated on the display.) Press PAR. Display reads [RL] for about 8 seconds.
7. Repeat steps 3 through 6 for each input range to be calibrated. When display reads [RL 00], press the PAR button to exit calibration.



# 5.3 MODULE 3 - DISPLAY AND FRONT PANEL BUTTON PARAMETERS (3-dSP)

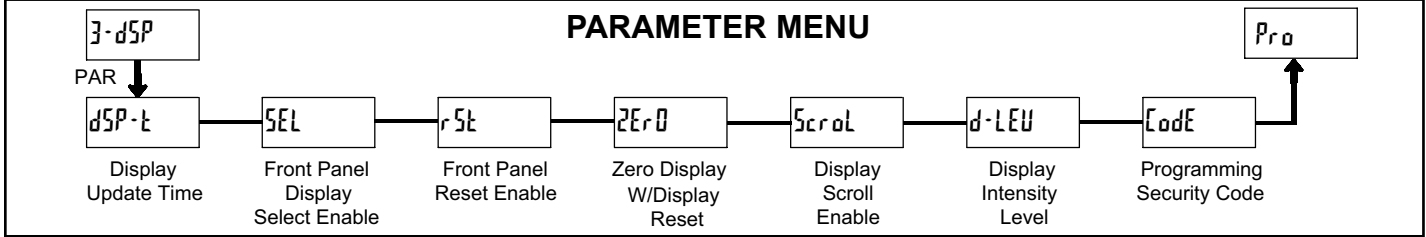

### DISPLAY UPDATE TIME

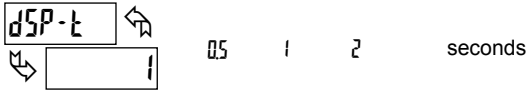

This parameter sets the display update time in seconds.

### FRONT PANEL DISPLAY SELECT ENABLE (SEL)



The YES selection allows the SEL button to toggle through the enabled displays.

### FRONT PANEL RESET ENABLE (RST)



This selection allows the RST button to reset the selected value(s).

### ZERO DISPLAY WITH DISPLAY RESET



This parameter enables the RST button or user input to zero the input display value, causing the display reading to be offset.

Note: For this parameter to operate, the RST button or User Input being used must be set to dSP and the Input value must be displayed. If these conditions are not met, the display will not zero.

### DISPLAY SCROLL ENABLE



The YES selection allows the display to automatically scroll through the enabled displays. The scroll rate is every 4 seconds. This parameter only appears when the MAX or MIN displays are enabled.

### DISPLAY INTENSITY LEVEL

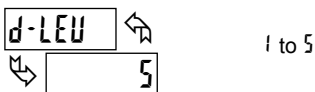

Enter the desired Display Intensity Level (1-5). The display will actively dim or brighten as levels are changed.

### PROGRAMMING SECURITY CODE



The Security Code determines the programming mode and the accessibility of programming parameters. This code can be used along with the Program Mode Lock-out (P-Loc) in the User Input Function parameter (Module 1).

Two programming modes are available. Full Programming mode allows all parameters to be viewed and modified. Quick Programming mode permits only the Setpoint values to be modified, but allows direct access to these values without having to enter Full Programming mode.

Programming a Security Code other than 0, requires this code to be entered at the CodE prompt in order to access Full Programming mode. Depending on the code value, Quick Programming may be accessible before the CodE prompt appears (see chart).

USER INPUT FUNCTION	USER INPUT STATE	SECURITY CODE	MODE WHEN "SEL" BUTTON IS PRESSED	FULL PROGRAMMING MODE ACCESS
not P-Loc	_____	0	Full Programming	Immediate Access
		1-99	Quick Programming	After Quick Programming with correct code entry at CodE prompt *
		100-999	CodE prompt	With correct code entry at CodE prompt *
P-Loc	Active	0	Programming Lock	No Access
		1-99	Quick Programming	No Access
		100-999	CodE prompt	With correct code entry at CodE prompt *
	Not Active	0-999	Full Programming	Immediate Access

# 5.4 MODULE 4 - SETPOINT OUTPUT PARAMETERS (4-SPt)

## PARAMETER MENU

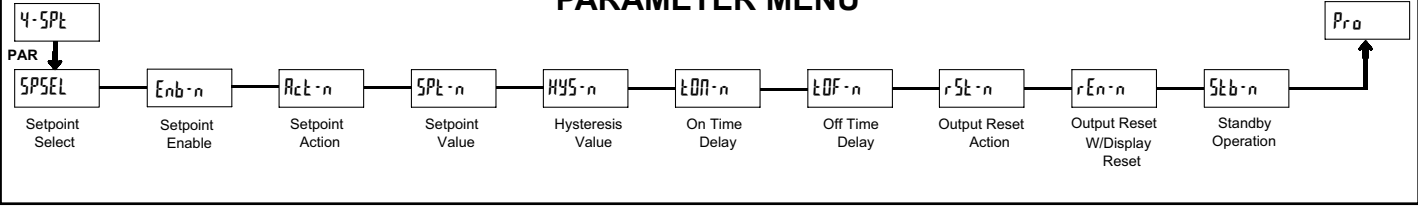

### SETPOINT SELECT



Enter the setpoint (output) to be programmed. The  $n$  in the following parameters will reflect the chosen setpoint number. After the chosen setpoint is completely programmed, the display will return to  $SPSEL$ . Repeat steps for each setpoint to be programmed. Select  $n0$  to exit the module.

### SETPOINT ENABLE



Select  $YES$  to enable Setpoint  $n$  and access the setup parameters. If  $n0$  is selected, the unit returns to  $SPSEL$  and Setpoint  $n$  is disabled.

### SETPOINT ACTION

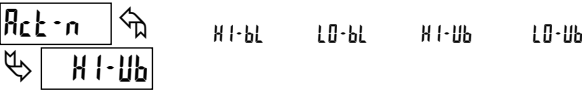

Enter the action for the selected setpoint (output). See Setpoint Output Figures for a visual detail of each action.

- $H1-bL$  = High Acting, with balanced hysteresis
- $LO-bL$  = Low Acting, with balanced hysteresis
- $H1-Ub$  = High Acting, with unbalanced hysteresis
- $LO-Ub$  = Low Acting, with unbalanced hysteresis

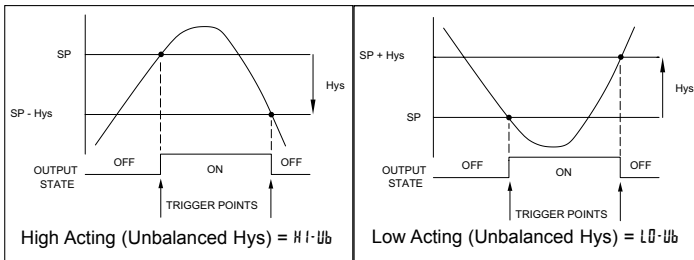
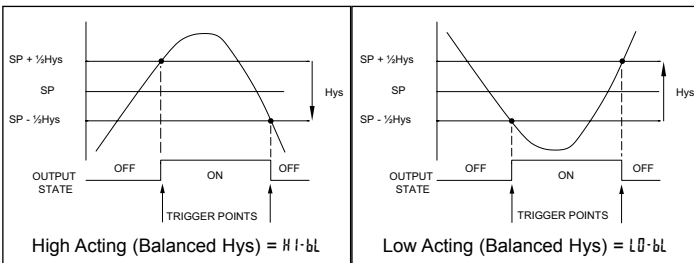

### SETPOINT VALUE



Enter the desired setpoint value. The decimal point position for the setpoint and hysteresis values follow the selection set in Module 1.

### HYSTERESIS VALUE



Enter desired hysteresis value. See Setpoint Output Figures for visual explanation of how setpoint output actions (balanced and unbalanced) are affected by the hysteresis. When the setpoint is a control output, usually balanced hysteresis is used. For alarm applications, usually unbalanced hysteresis is used. For unbalanced hysteresis modes, the hysteresis functions on the low side for high acting setpoints and functions on the high side for low acting setpoints.

*Note: Hysteresis eliminates output chatter at the switch point, while time delay can be used to prevent false triggering during process transient events.*

### ON TIME DELAY



Enter the time value in seconds that the output is delayed from turning on after the trigger point is reached. A value of 0.0 allows the meter to update the output status per the response time listed in the Specifications.

### OFF TIME DELAY



Enter the time value in seconds that the output is delayed from turning off after the trigger point is reached. A value of 0.0 allows the meter to update the output status per the response time listed in the Specifications.

### OUTPUT RESET ACTION

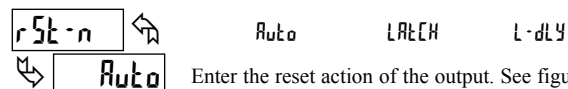

Enter the reset action of the output. See figure for details.

$Auto$  = Automatic action; This action allows the output to automatically reset off at the trigger points per the Setpoint Action shown in Setpoint Output Figures. The "on" output may be manually reset (off) immediately by the front panel **RST** button or user input. The output remains off until the trigger point is crossed again.

$LATCH$  = Latch with immediate reset action; This action latches the output on at the trigger point per the Setpoint Action shown in Setpoint Output Figures. Latch means that the output can only be turned off by the front panel **RST** button or user input manual reset, serial reset command or meter power cycle. When the user input or **RST** button is activated (momentary action), the

corresponding “on” output is reset immediately and remains off until the trigger point is crossed again. (Previously latched alarms will be off if power up Display Value is lower than setpoint value.)

**L-dLY** = Latch with delay reset action; This action latches the output on at the trigger point per the Setpoint Action shown in Setpoint Output Figures. Latch means that the output can only be turned off by the front panel **RST** button or user input manual reset, serial reset command or meter power cycle. When the user input or **RST** button is activated (momentary action), the meter delays the event until the corresponding “on” output crosses the trigger off point. (Previously latched outputs are off if power up Display Value is lower than setpoint value. During a power cycle, the meter erases a previous L-dLY reset if it is not activated at power up.)

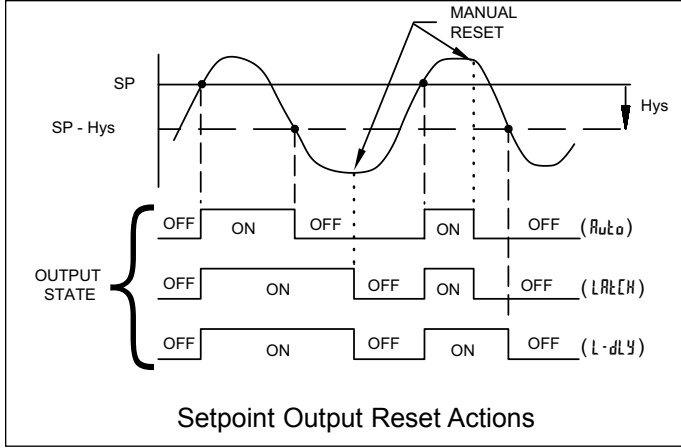

### OUTPUT RESET WITH DISPLAY RESET



This parameter enables the **RST** button or user input to reset the output when the display is reset.

Note: For this parameter to operate, the **RST** button or User Input being used must be set to **dSP** and the Input value must be displayed. If these conditions are not met, the output will not reset.

### STANDBY OPERATION



When **YES**, the output is disabled (after a power up) until the trigger point is crossed. Once the output is on, the output operates normally per the Setpoint Action and Output Reset Action.

## 5.5 MODULE 5 - SERIAL SETUP PARAMETERS (5-5Er)

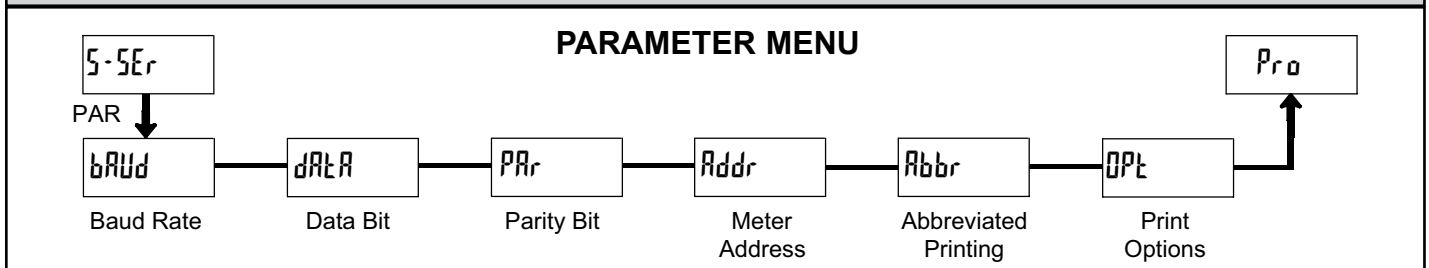

Module 5 is the programming module for the Serial Communications Parameters. These parameters are used to match the serial settings of the LD with those of the host computer or other serial device.

### BAUD RATE



Set the baud rate to match that of other serial communications equipment. Normally, the baud rate is set to the highest value that all of the serial communications equipment is capable of transmitting and receiving.

### DATA BIT



Select either 7- or 8-bit data word length. Set the word length to match the other serial communications equipment on the serial link.

### PARITY BIT



This parameter only appears when the Data Bit parameter is set to a 7-bit data word length. Set the parity bit to match that of the other serial equipment on the serial link. The meter ignores parity when receiving data and sets the parity bit for outgoing data. If parity is set to **NO**, an additional stop bit is used to force the frame size to 10 bits.

## METER ADDRESS

Addr  0 to 99  
 00

Enter the serial node address. With a single unit, an address is not needed and a value of zero can be used (RS232 applications). Otherwise, with multiple bussed units, a unique address number must be assigned to each meter. The node address applies specifically to RS485 applications.

## ABBREVIATED PRINTING

Abbr  NO YES  
 NO

This parameter determines the formatting of data transmitted from the meter in response to a Transmit Value command or a Block Print Request. Select **NO** for a full print transmission, consisting of the meter address, mnemonics, and parameter data. Select **YES** for abbreviated print transmissions, consisting of the parameter data only. This setting is applied to all the parameters selected in the PRINT OPTIONS. (Note: If the meter address is 0, the address will not be sent during a full transmission.)

## PRINT OPTIONS

OPT  NO YES  
 NO

This parameter selects the meter values transmitted in response to a Print Request. A print request is also referred to as a block print because more than one parameter can be sent to a printer or computer as a block.

Selecting **YES** displays a sublist for choosing the meter parameters to appear in the print block. All active parameters entered as **YES** in the sublist will be transmitted during a block print. Parameters entered as **NO** will not be sent.

The "Print All" (**P ALL**) option selects all meter values for transmitting (**YES**), without having to individually select each parameter in the sublist.

Note: Inactive parameters will not be sent regardless of the print option setting. The Setpoint value will not be sent unless the setpoint is enabled

DISPLAY	DESCRIPTION	FACTORY SETTING	MNEMONIC
INP	Input	YES	INP
HI	Maximum	NO	MAX
LO	Minimum	NO	MIN
SP1-1	Setpoint 1	NO	SP1
SP1-2	Setpoint 2	NO	SP2

## Sending Serial Commands and Data

When sending commands to the meter, a string containing at least one command character must be constructed. A command string consists of a command character, a value identifier, numerical data (if writing data to the meter) followed by a command terminator character, \* or \$.

### Command Chart

Command	Description	Notes
N	Node (meter) Address Specifier	Address a specific meter. Must be followed by one or two digit node address. Not required when node address = 0.
T	Transmit Value (read)	Read a register from the meter. Must be followed by a register ID character.
V	Value Change (write)	Write to register of the meter. Must be followed by a register ID character and numeric data.
R	Reset	Reset a min or max value or the output. Must be followed by a register ID character
P	Block Print Request (read)	Initiates a block print output. Registers in the print block are selected in Print Options.

### Command String Construction

The command string must be constructed in a specific sequence. The meter does not respond with an error message to illegal commands. The following procedure details construction of a command string:

1. The first 2 or 3 characters consist of the Node Address Specifier (N) followed by a 1 or 2 character node address number. The node address number of the meter is programmable. If the node address is 0, this command and the node address itself may be omitted. This is the only command that may be used in conjunction with other commands.
2. After the optional address specifier, the next character is the command character.
3. The next character is the register ID. This identifies the register that the command affects. The P command does not require a register ID character. It prints all the active selections chosen in the Print Options menu parameter.
4. If constructing a value change command (writing data), the numeric data is sent next.
5. All command strings must be terminated with the string termination characters \* or \$. The meter does not begin processing the command string until this character is received. See timing diagram figure

### Register Identification Chart

ID	Value Description	MNEMONIC	Applicable Commands	Transmit Details (T and V)
A	Input	INP	T, R	5 digit
B	Maximum	MAX	T, R	5 digit
C	Minimum	MIN	T, R	5 digit
D	Setpoint 1	SP1	T, R, V	5 digit positive/4 digit negative
E	Setpoint 2	SP2	T, R, V	5 digit positive/4 digit negative

### Command String Examples:

1. Node address = 17, Write 350 to the Setpoint 1 value  
String: N17VD350\$
2. Node address = 5, Read Input, response time of 50 msec min  
String: N5TA\*
3. Node address = 31, Request a Block Print Output, response time of 2 msec min  
String: N31P\$

### Transmitting Data to the Meter

Numeric data sent to the meter must be limited to transmit details listed in the Register Identification Chart. Leading zeros are ignored. Negative numbers must have a minus sign. The meter ignores any decimal point and conforms the number to the scaled resolution. (For example: The meter's scaled decimal point position is set for 0.0 and 25 is written to a register. The value of the register is now 2.5. In this case, write a value of 250 to equal 25.0).

Note: Since the meter does not issue a reply to value change commands, follow with a transmit value command for readback verification.

## Receiving Data From The Meter

Data is transmitted from the meter in response to either a transmit command (T), a block print request command (P) or a User Input print request. The response from the meter is either a full field transmission or an abbreviated transmission, depending on the selection chosen in Module 5.

### Full Field Transmission

Byte	Description
1, 2	2 byte Node Address field [00-99]
3	<SP> (Space)
4-6	3 byte Register Mnemonic field
7-15	9 byte data field; 7 bytes for number, one byte for sign, one byte for decimal point
16	<CR> (carriage return)
17	<LF> (line feed)
18	<SP>* (Space)
19	<CR>* (carriage return)
20	<LF>* (line feed)

\* These characters only appear in the last line of a block print.

The first two characters transmitted are the meter address. If the address assigned is 0, two spaces are substituted. A space follows the meter address field. The next three characters are the register mnemonic, as shown in the Register Identification Chart.

The numeric data is transmitted next. The numeric field (bytes 7 to 15) is 9 characters long. This field consists of a minus sign (for negative values), a floating decimal point (if applicable), and five positions for the requested value. The data within bytes 9 to 15 is right-aligned with leading spaces for any unfilled positions. When a requested value exceeds the meter's display limits, decimal points are transmitted instead of a numeric value.

The end of the response string is terminated with a <CR> and <LF>. After the last line of a block print, an extra <SP>, <CR> and <LF> are added to provide separation between the print blocks.

### Abbreviated Transmission

Byte	Description
1-9	9 byte data field, 7 bytes for number, one byte for sign, one byte for decimal point
10	<CR> (carriage return)
11	<LF> (line feed)
12	<SP>* (Space)
13	<CR>* (carriage return)
14	<LF>* (line feed)

\* These characters only appear in the last line of a block print.

The abbreviated response suppresses the node address and register ID, leaving only the numeric part of the response.

### Meter Response Examples:

- Node address = 17, full field response, Input = 875  
17 INP 875 <CR><LF>
- Node address = 0, full field response, Setpoint 1 = -250.5  
SP1 -250.5<CR><LF>
- Node address = 0, abbreviated response, Setpoint 2 = 250, last line of block print  
250<CR><LF><SP><CR><LF>

## Command Response Time

The meter can only receive data or transmit data at any one time (half-duplex operation). During RS232 transmissions, the meter ignores commands while transmitting data, but instead uses RXD as a busy signal. When sending commands and data to the meter, a delay must be imposed before sending another command. This allows enough time for the meter to process the command and prepare for the next command.

At the start of the time interval  $t_1$ , the computer program prints or writes the string to the com port, thus initiating a transmission. During  $t_1$ , the command characters are under transmission and at the end of this period, the command terminating character (\* or \$) is received by the meter. The time duration of  $t_1$  is dependent on the number of characters and baud rate of the channel.

$$t_1 = (10 \text{ times the \# of characters}) / \text{baud rate}$$

At the start of time interval  $t_2$ , the meter starts the interpretation of the command and when complete, performs the command function. This time interval  $t_2$  varies. If no response from the meter is expected, the meter is ready to accept another command.

If the meter is to reply with data, the time interval  $t_2$  is controlled by the use of the command terminating character. The "\*" terminating character results in a response time of 50 msec. minimum. This allows sufficient time for the release of the sending driver on the RS485 bus. Terminating the command line with '\$' results in a response time ( $t_2$ ) of 2 msec. minimum. The faster response time of this terminating character requires that sending drivers release within 2 msec. after the terminating character is received.

At the beginning of time interval  $t_3$ , the meter responds with the first character of the reply. As with  $t_1$ , the time duration of  $t_3$  is dependent on the number of characters and baud rate of the channel. At the end of  $t_3$ , the meter is ready to receive the next command.

$$t_3 = (10 \text{ times the \# of characters}) / \text{baud rate}$$

The maximum serial throughput of the meter is limited to the sum of the times  $t_1$ ,  $t_2$  and  $t_3$ .

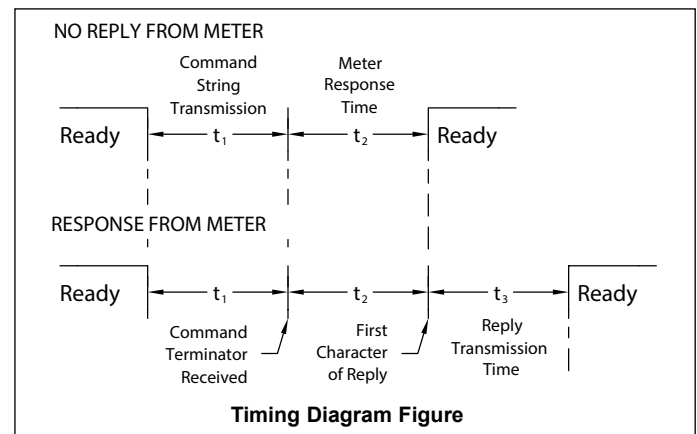

# Communication Format

Data is transferred from the meter through a serial communication channel. In serial communications, the voltage is switched between a high and low level at a predetermined rate (baud rate) using ASCII encoding. The receiving device reads the voltage levels at the same intervals and then translates the switched levels back to a character. The voltage level conventions depend on the interface standard. The table lists the voltage levels for each standard.

LOGIC	INTERFACE STATE	RS232*	RS485*
1	mark (idle)	TXD,RXD; -3 to -15 V	a-b < -200 mV
0	space (active)	TXD,RXD; +3 to +15 V	a-b > +200 mV
* Voltage levels at the Receiver			

Data is transmitted one byte at a time with a variable idle period between characters (0 to ∞). Each ASCII character is “framed” with a beginning start bit, an optional parity bit and one or more ending stop bits. The data format and baud rate must match that of other equipment in order for communication to take place. The figures list the data formats employed by the meter.

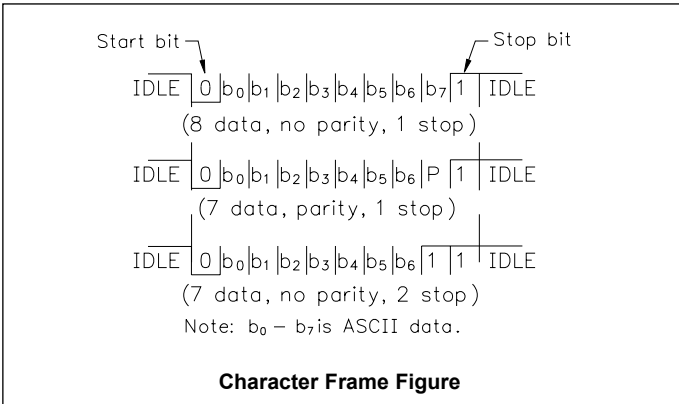

## Start Bit and Data Bits

Data transmission always begins with the start bit. The start bit signals the receiving device to prepare for reception of data. One bit period later, the least significant bit of the ASCII encoded character is transmitted, followed by the remaining data bits. The receiving device then reads each bit position as they are transmitted.

## Parity Bit

After the data bits, the parity bit is sent. The transmitter sets the parity bit to a zero or a one, so that the total number of ones contained in the transmission (including the parity bit) is either even or odd. This bit is used by the receiver to detect errors that may occur to an odd number of bits in the transmission. However, a single parity bit cannot detect errors that may occur to an even number of bits. Given this limitation, the parity bit is often ignored by the receiving device. The meter ignores the parity bit of incoming data and sets the parity bit to odd, even or none (mark parity) for outgoing data.

## Stop Bit

The last character transmitted is the stop bit. The stop bit provides a single bit period pause to allow the receiver to prepare to re-synchronize to the start of a new transmission (start bit of next byte). The receiver then continuously looks for the occurrence of the start bit. If 7 data bits and no parity is selected, then 2 stop bits are sent from the meter.

# LDA PROGRAMMING QUICK OVERVIEW

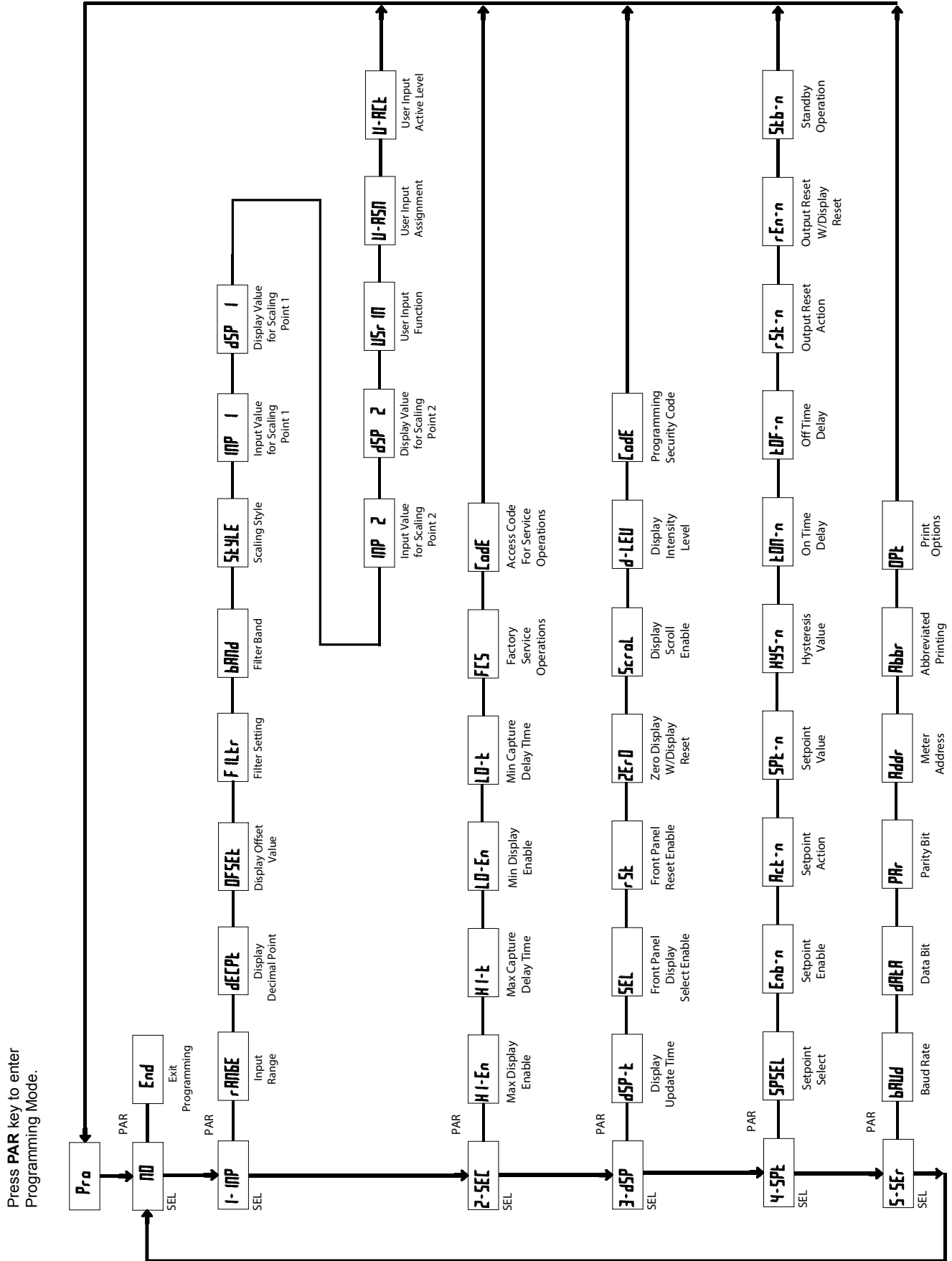



#### **LIMITED WARRANTY**

(a) Red Lion Controls Inc., Sixnet Inc., N-Tron Corporation, or Blue Tree Wireless Data, Inc. (the "Company") warrants that all Products shall be free from defects in material and workmanship under normal use for the period of time provided in "Statement of Warranty Periods" (available at [www.redlion.net](http://www.redlion.net)) current at the time of shipment of the Products (the "Warranty Period"). **EXCEPT FOR THE ABOVE-STATED WARRANTY, COMPANY MAKES NO WARRANTY WHATSOEVER WITH RESPECT TO THE PRODUCTS, INCLUDING ANY (A) WARRANTY OF MERCHANTABILITY; (B) WARRANTY OF FITNESS FOR A PARTICULAR PURPOSE; OR (C) WARRANTY AGAINST INFRINGEMENT OF INTELLECTUAL PROPERTY RIGHTS OF A THIRD PARTY; WHETHER EXPRESS OR IMPLIED BY LAW, COURSE OF DEALING, COURSE OF PERFORMANCE, USAGE OF TRADE OR OTHERWISE.** Customer shall be responsible for determining that a Product is suitable for Customer's use and that such use complies with any applicable local, state or federal law.

(b) The Company shall not be liable for a breach of the warranty set forth in paragraph (a) if (i) the defect is a result of Customer's failure to store, install, commission or maintain the Product according to specifications; (ii) Customer alters or repairs such Product without the prior written consent of Company.

(c) Subject to paragraph (b), with respect to any such Product during the Warranty Period, Company shall, in its sole discretion, either (i) repair or replace the Product; or (ii) credit or refund the price of Product provided that, if Company so requests, Customer shall, at Company's expense, return such Product to Company.

(d) **THE REMEDIES SET FORTH IN PARAGRAPH (c) SHALL BE THE CUSTOMER'S SOLE AND EXCLUSIVE REMEDY AND COMPANY'S ENTIRE LIABILITY FOR ANY BREACH OF THE LIMITED WARRANTY SET FORTH IN PARAGRAPH (a).**